



owner's manual EN v3.0

introduction 1

uses and features of the Vac410 1

safety information 2

installation 2

risks 2

equipment 2

operation 3-7

startup preparation/oil level examination 3

controls 4

program adjustments 5

operation 6

oil change 7

general information 8-10

maintenance 8

product specifications 8

product dimensions 9

electrical diagram 10

troubleshooting 11

common failures & troubleshooting methods 11

other 12-13

warranty 12

packaging list 12

spare parts 12

distributor contact info 12

replacement parts 13

Dear user, please read this manual carefully before operating the equipment. Proper use is very important to prevent damage to the machine and personal injury. The potential dangers during operation and maintenance of the equipment are described through symbols in this manual. The following symbols are used in the text for your reference.



Safety warning: This symbol indicates a safety precaution to be taken to eliminate equipment malfunction and protect your personal safety.



Notes: This symbol represents the basic information of the equipment and methods or techniques used by the user.

The manufacturer has reviewed the contents of this manual and it can't be guaranteed that the contents are exactly the same as the actual situation due to human error. Reviews will be made periodically to make necessary corrections and update accordingly. If you have any concerns about the performance or operation of the equipment after referring to this manual, please contact your distributor prior to use.



We are not responsible for any equipment malfunction or accident caused by installation and use of failure to follow the contents of this manual. All the copyrights of this manual are owned by the company and are strictly prohibited from spreading, copying and other infringing actions. In case of any infringement, the company will retain the right to sue.



Precautions should be taken to prevent damage to equipment when removing packaging. Please check whether the delivered equipment matches what you ordered. If the delivery is incomplete or damaged, please notify the distributor immediately.

PACKAGE CONTENTS



QUART OF OIL

CHECK OIL LEVEL BEFORE OPERATING



FUNNEL

USE FOR OIL



REPLACEMENT HEAT STRIP (QTY - 2)

REPLACE HEAT STRIP IN BAR AT END OF LIFE



REPLACEMENT SEAL BAR TAPE (QTY - 2)

REPLACE THE SEAL BAR TAPE AT END OF LIFE



REPLACEMENT LID CHAMBER GASKET

REPLACE WHEN LID GASKET IS AT END OF LIFE



FILLER PLATES (QTY - 2)

USE TO REDUCE EXCESS SPACE IN CHAMBER

uses and features of the Vac410



The Vac410 machine is a chamber style vacuum packaging machine. Superior to non-chamber, suction type machines, the Vac410 delivers a higher level of vacuum and more reliable seals. Equipped with dual oil lubricated, rotary vane vacuum pumps, this unit will last under many years of heavy usage. With the added benefit of sealing liquid items, this chamber vacuum sealer will surpass all expectations.

Many products benefit from being vacuum packaged, food can be kept fresher longer and shelf life prolonged, for some items, it can effectively reduce the size making them easier to transport and store. It can be widely used in food, medicine, electronics, chemicals and other fields, one of the best choices for factories, shops, homes, restaurant, and more. The Vac410 is controlled by a low voltage digital control board, it is safe, reliable, simple to operate and easy to maintain. Constructed of corrosion resistant stainless steel and built to last. Adjustable vacuum, sealing, and cooling times to accommodate different packaging materials and requirements.

INSTALLATION



The Vac410 requires a dedicated, 220 volt, single phase, 20 amp power supply. These machines do not ship with a plug installed and therefore a licensed electrician will be required. Contact an authorized distributor if any questions arise during the installation process.

- This equipment should only be used indoors.
- Do NOT spray or hose down this equipment.
- The presence of flammable gases or flammable vapors is prohibited around the equipment.
- The equipment must be used on a stable and level surface.
- The power cord must be unplugged before the equipment is transported, cleaned or moved.
- Equipment must remain upright when transported to avoid leakage and potential damage to the vacuum pump.
- Please note the safety symbols or notes pasted on the equipment.

RISKS



To avoid serious injury, unplug the machine prior to performing any service!

- When the equipment is connected to the power, it must be compatible with the rated power, frequency and voltage listed on the ID tag located on the back cover.
- Equipment must be plugged into a grounded receptacle.
- Do not use an extension cord when plugging in this equipment.

EQUIPMENT

- Check oil level in vacuum pump prior to first use and on a weekly basis.
- If any damage or oil leakage is found please contact your distributor prior to running.
- Never leave the machine unattended while operating! Disconnect power when the equipment is not in use.
- Using a damp cloth, wipe off the seal bar tape on the seal bar after each use.
- Reduce vacuum time when sealing liquids to prevent boil over and contamination to the vacuum chamber.
- Products being packaged must fit comfortably inside vacuum chamber. Under no circumstance should the lid be forced down in order to accommodate an oversized product.

START-UP PREPARATION



The following actions must be taken before running!

- The machine must be placed on a stable and level surface. The environment should be clean and dry with a room temperature of 50°F – 85°F.
- The unit needs to be plugged directly into a 220V, 3 pronged, grounded receptacle. Extension cords should not be used.
- Before operating, vacuum pump oil level should be $\frac{3}{4}$ full when viewed through the sight glass. If the oil level is less than $\frac{1}{2}$, then fill to the $\frac{3}{4}$ level. If oil level is too high or too low it will affect the pump performance and reliability.
- Set the heating time and temperature according to the thickness of the material. If you are not sure about the time and temperature settings then please consult with your distributor.

OIL LEVEL EXAMINATION

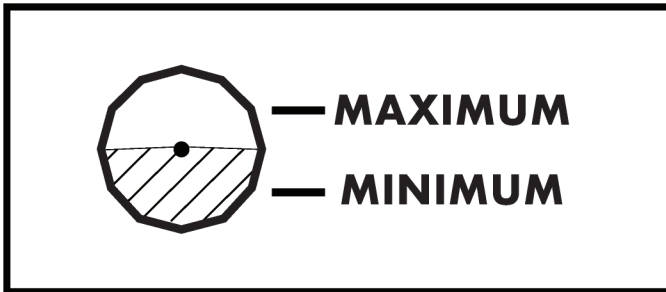

- Checking the oil level of vacuum pump. The sight glass may be viewed through the viewing window on the back panel.
- If the oil level is low, add the appropriate vacuum oil (REFERENCE PART# 100-08 in the "REPLACEMENT PARTS" section) must be non-detergent, the use of motor oil is strictly prohibited. Contact your distributor if you have any questions.

CONTROLS



The incorrect setting methods may affect the performance of the machine or the package integrity.

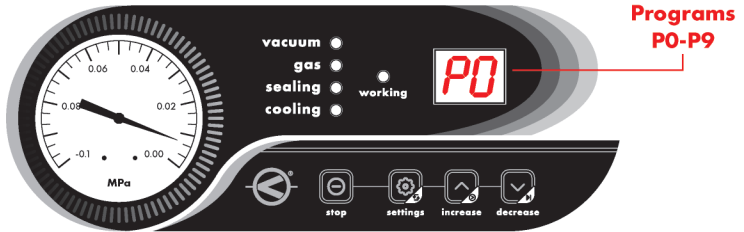

Basic Stop Function

Press & Release Function: *Change Settings*

Press & Hold (3 seconds) Function: *Program number will blink, use increase & decrease to change program. Press settings to load program*



Increase time or program number

Press & Hold (3 Seconds) Function: *Manual Pump Mode for testing and troubleshooting. NOTE: If constant beep occurs turn off your machine, turn on, & try again.*



Decrease time or program number

SKIP function during vacuum cycle *abruptly ends vacuum & skips to the seal cycle.*



Disconnect switch (power on/off)

The disconnect switch can be found on the left panel.





PROGRAM ADJUSTMENTS

Press & hold the **SETTINGS** button () once to enter the programs menu. If at any time you would like to exit the programs, press the **SETTINGS** button ().

The first screen to appear will display your program number. Press increase/decrease to select a different program number. This machine is capable of storing 9 unique programs, P0-P9. P0 comes preset with 25 seconds of vacuum and will provide the maximum amount of vacuum. Vacuum will need to be decreased for liquid items in order to prevent boil-over or the **SKIP** function can be used.

Upon selecting the program you wish to edit, press the **SETTINGS** button () to exit out of the programs menu. Press the **SETTINGS** button () one more time to enter the settings menu to illuminate vacuum cycle times.



VACUUM, SEALING AND COOLING

VACUUM TIME SETTING: press increase/decrease buttons to set a time of 0-99S. NOTE: 20-40 seconds is recommended for most items. Press the **SETTINGS** button () to save and enter into the next step.

GAS TIME SETTING: ONLY AVAILABLE ON GAS MODELS
press increase/decrease buttons to set a time of 0-9.9S. Press the **SETTINGS** button () to save and enter into the next step.



SEALING TIME SETTING: press increase/decrease buttons to set a time of 0-3.0S. NOTE: 1.5-1.9 seconds is recommended to properly seal most pouches. It is recommended that you start with a lower setting and increase until a satisfactory seal is achieved. Press the **SETTINGS** button () to save and enter into the next step.

COOLING TIME SETTING: press increase/decrease buttons to set a time of 2-9.9S. NOTE: 3 seconds is recommended for most items. This is the final setting, press the **SETTINGS** button () to save and return to STANDBY.

OPERATION



Incorrect or improper methods of operation will negatively affect the machines performance.

- Turn on the **DISCONNECT** switch (), and confirm settings. See pg. 5.
- Select chamber vacuum pouches with the appropriate size and material. Load the product into the bag and wipe off any contamination around the area of the bag being sealed.
- Carefully lay the loaded bag into the vacuum chamber with the open end laid flat across the seal bar. It is recommended that the pouch be long enough to fully insert into the black hold-down clips. The use of these clips is not required but, in all cases, the pouch must be long enough to lay flat across the seal bar. The most common cause for packages to lose vacuum over time are due to creases and wrinkles in the seal area of the vacuum pouch. **NOTE:** the open end of the bag must be inside the vacuum chamber. When the lid is closed, if it hangs out of the chamber, it will not be able to extract the air from the package.
- Close the lid firmly to start the cycle. After a couple seconds, the vacuum inside the chamber will suck the lid shut, at this time you may remove your hands from lid. If at any time the machine needs to be stopped immediately then the **STOP** button () may be used.
- Upon completion of cycle the chamber will vent and the lid will release and spring open. **CAUTION:** Keep head and hands clear until the lid springs open automatically.
- **CAUTION:** The heat seal bar may be hot shortly after the lid springs open. Please take caution when removing the vacuum sealed item from the chamber.
- When machine is not in use, turn off the **DISCONNECT** switch ().

OIL CHANGE

The quality of the oil will directly affect the performance and service life of the vacuum pump. It is recommended that the first oil change occur at 150 hours or 3 months of usage. Every future change should occur at 500 hours or every 6 months, whichever comes first.

NOTE: If the machine is used in a humid environment or if the products being packaged contain a high moisture content then more frequent oil changes are recommended.

- Unplug machine from wall outlet.
- Remove the two screws on top and bottom of viewing window to access oil pump.
- Using a suitable container to collect the oil, remove the oil drain screw **3**
- After the oil has drained, reinstall the oil drain screw. **3**
- To refill, twist off the fill cap. **1**
- Add oil and fill to the appropriate level on sight glass. **2**
- Re-install the fill plug. Repeat all steps for the second vacuum pump. **1**
- Run a cycle and check oil level. Top off if necessary.

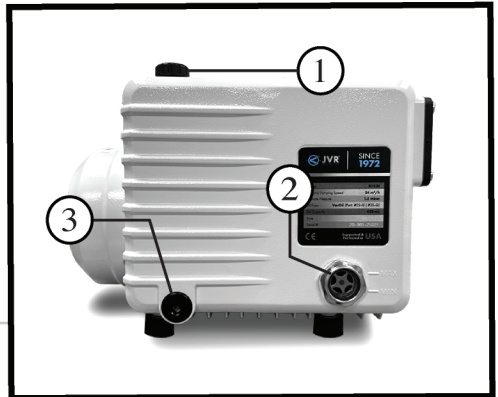

MAINTENANCE

• Regularly check the vacuum pump oil level and fill if less than ½ full. Refer to pg. 7.

• First oil change should be performed after 150 hours of operation, after that every 500 working hours please change the oil. Exhaust filter should be replaced once every year.

• Regularly check the machine fasteners and tighten if necessary. Check the lid hinge mechanism and grease pivot points.

• Inspect the heating element and seal bar tape. If the wire is broken then replace immediately. Replace the tape if burnt or when the bags begin to stick to the seal bar.

PRODUCT SPECIFICATIONS

Model	Vac410
Voltage	220V/60HZ/1 PH
Amps	14 Amps
Gas extraction rate	20m ³ /h \geq 0.09Mpa (x2)
Vacuum oil type	ISOVG 22
Oil Capacity	0.5 Quarts (x2)
Machine weight	350 lbs
Vacuum chamber size	24.7" x 24.7" x 6.3"
Sealing bar length	24" (x2)
Distance from seal bar to seal bar	21"
Overall dimension (W,D,H)	29.0" x 29.0" x 38.5"

PRODUCT DIMENSIONS

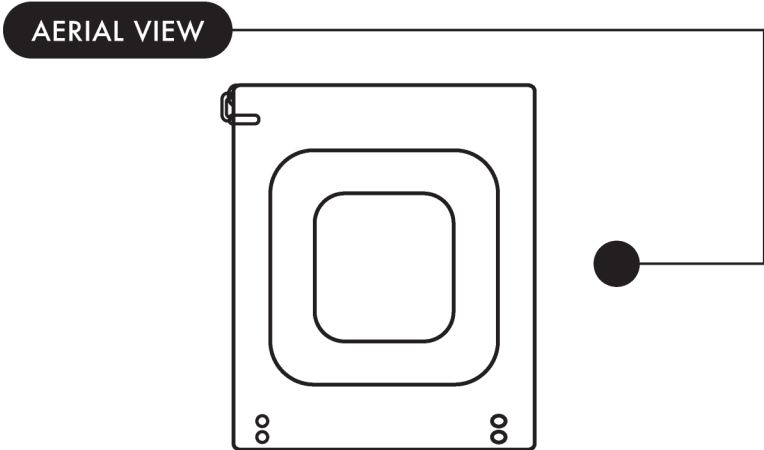
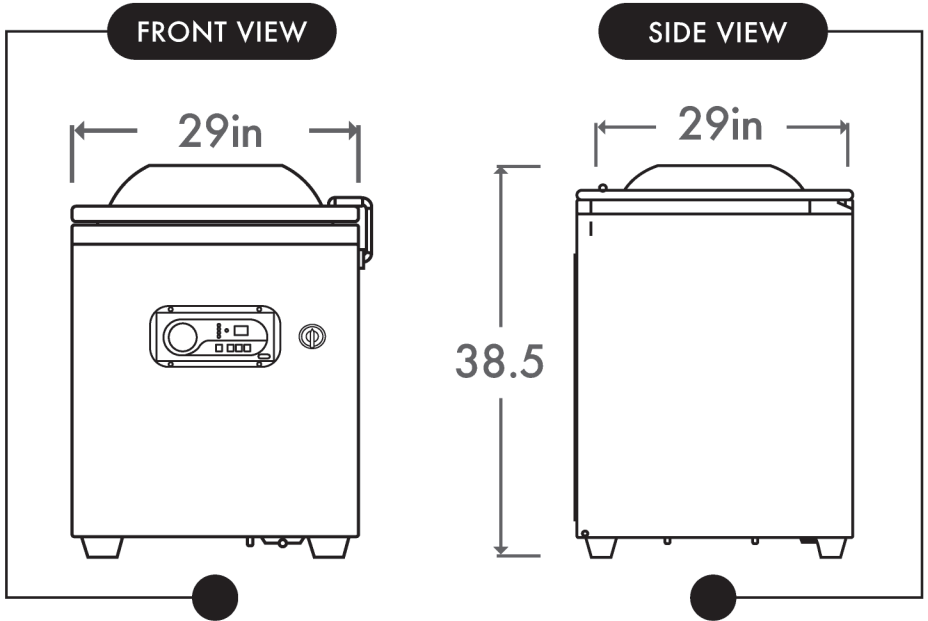

ELECTRICAL DIAGRAM



To avoid serious injury, unplug the machine prior to performing any service! Only those familiar with the operation of this equipment or professional maintenance personnel may conduct the maintenance.

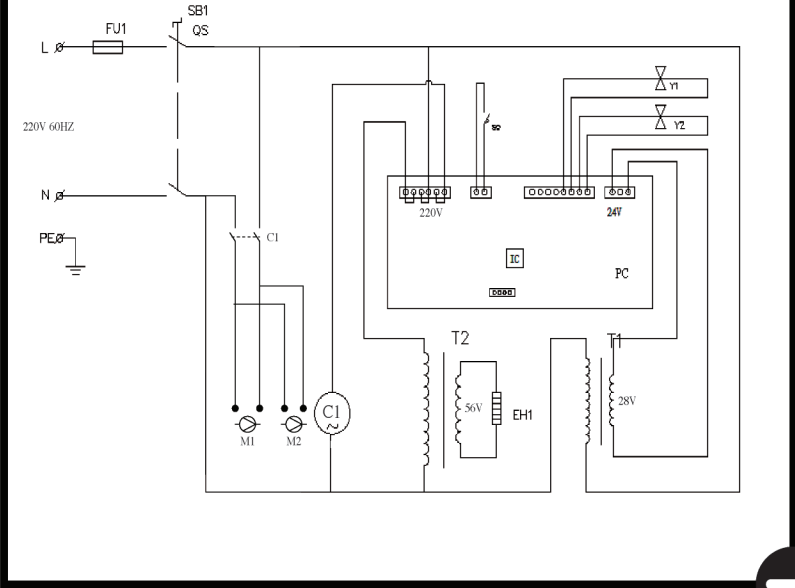

COMMON FAILURES AND TROUBLESHOOTING METHODS

FAULT	REASONS	CORRECTIVE ACTION
Machine won't turn on	No power supplied to machine	Check the connection of power cable
	Disconnect switch is turned off	Check the disconnect switch on side of machine
	None of the above	Contact your distributor
Poor vacuum, packages are loose	Vacuum time set too low	Increase vacuum time (refer to pg. 5)
	Rubber lid chamber gasket is damaged	Replace lid chamber gasket
	Vacuum pump oil is low	Add vacuum pump oil to pump (refer to pg. 8-9)
	None of the above	Contact your distributor
Poor heat seal on packages	Seal time is set too low or too high	Adjust seal time (refer to pg. 5)
	The upper seal cushion is damaged	Replace seal cushion
	The heat strip is damaged or broken	Replace heat strip and seal bar tape
	Seal bar is not lifting	Seal cylinders may need replacement, contact your distributor to confirm
	None of the above	Contact your distributor
Cycle won't start when lid is closed	Cycle start switch is damaged or defective	Start switch may need replacement, contact your distributor to confirm
Seal contamination when sealing liquids	Vacuum time set too high resulting in boil over	Reduce vacuum time setting (refer to pg. 5)
	None of the above	Contact your distributor

WARRANTY

The warranty on this machine is active for 12 months after the date of purchase. If you experience any issues please contact your distributor to determine the correct course of action.

***** REFER TO THE INCLUDED LIMITED WARRANTY PAGE *****

PACKING LIST

NAME	PART #	QTY
<i>filler plate</i>	410-09	2
<i>owner's manual</i>	N/A	1 copy

















SPARE PARTS

NAME	PART #	QTY
<i>vacuum pump oil</i>	#22-Q	1
<i>lid chamber gasket</i>	410-10	1
<i>heat strip</i>	410-17	2
<i>seal bar tape</i>	410-16	2

5.4 DISTRIBUTOR CONTACT INFO:

Empty rectangular box for distributor contact information.

REPLACEMENT PARTS

IMG	NAME	PART #
	<i>Seal/Cut Bar Assembly</i>	410-15C
	<i>Seal Bar Assembly</i>	410-15N
	<i>Heat Strip</i>	410-17
	<i>Seal Bar Tape (24")</i>	410-16
	<i>Seal Cushion Strip</i>	410-19
	<i>Seal Bar Lift Piston (INDIVIDUAL)</i>	410-25
	<i>Small Control Transformer</i>	410-61
	<i>Large Seal Transformer</i>	410-62
	<i>Vacuum Pump RVS20 (220V)</i>	RVS20-220
	<i>Seal Valve</i>	410-39
	<i>Vent Valve</i>	610-38SMC-V
	<i>Pump Exhaust Filter</i>	RVS20-32
	<i>Controls, 2nd Generation</i>	410-501a
	<i>Lid Chamber Gasket</i>	410-10
	<i>Vacuum Pump Oil</i>	#22-Q
	<i>Lid Shock</i>	410-42